

RUGGED GALAXY™ SERIES PURE-SINEWAVE DC-AC INVERTERS

Extended Input Range: 450-950 VDC

AC Output: Single or Three Phase

50, 60, or 400 Hz

Power: 1 - 35+ KVA



APPLICATIONS

Utilizing field proven technology, this family of rugged pure sinewave DC-AC Inverters is suitable for harsh environments and can be customized for unique applications including:

- Work Trains
- Subways
- Trolleys
- Locomotives



NOVA ELECTRIC

www.novaelectric.com

novasales@theallpower.com

AS 9100
BUREAU VERITAS
Certification
Certificate No: US000267-1



A Leader in DC-AC Inverter Technology since 1966 - 500VA to 35+KVA

MADE IN USA

RUGGED PURE SINEWAVE DC-AC INVERTER

CAN MEET MIL-STD-810, MIL-STD-1399, MIL-S-901, MIL-STD-704, & MIL-STD-461 OPTIONALLY

APPLICATIONS

The transformer isolated Galaxy Series Inverters are extremely rugged by design, and feature an advanced Internal Suppression Filter Network (ISFN) to suppress the significant transients usually associated with railway and third rail applications. The units are also extremely reliable, designed to provide many years of service in harsh shock, vibration, humidity, and EMI environments.

HIGH-RELIABILITY

MTBF: 100,000 Hours per field data
MTBR: 30 Minutes (assuming qualified tech)

STANDARD INDICATORS

- Input Power On Lamp

SPECIFICATIONS

ELECTRICAL

Input: 500-750VDC (Extended Available)
Output: specify 120 or 220VAC 1Ø
(Three-Phase Output Optional)
Frequency: Specify 50, 60, or 400Hz
Voltage Regulation: $\pm 1.5\%$ NL to FL
Frequency Regulation: $\pm 0.5\%$ NL to FL
Harmonic Distortion: 5% THD
Power Factor: 0.7 lead to 0.7 lag
Efficiency at full load: 90% typical
Overload: 125% for 5 minutes

PROTECTIVE FEATURES

Current Limit, Short Circuit Protection, Thermal Protection, Semiconductor Protection, and ISFN; Input OV/UV Alarm and Monitor with Contact Closures.

ENVIRONMENTAL

Operating Temp.: -20° to +50°C
Storage Temp. Range: -40° to +71°C
Humidity: to 95% non-condensing
Elevation: 15,000 Ft. (4.572m) operating;
40,000 ft. (12.192m) non-operating
Shock: 20g for 11mS
Audible Noise: Less than 55 dbA at 5 ft.

POPULAR OPTIONS

- Ruggedization
- Undercarriage Cabinets
- Additional Meters
- Static Transfer Switch
- RS232 or SNMP
- Higher Capacities up to 60KVA

SINGLE PHASE MODEL SELECTION

MODELS	OUTPUT VAC	OUTPUT FREQ	OUTPUT POWER	DIMENSIONS H x W x D (Inches)
GH1K60-600	120	60	1KVA	30.0 x 24.0 x 8.0
GH2K60-600	120	60	2KVA	30.0 x 24.0 x 8.0
GH3K60-600	120	60	3KVA	30.0 x 24.0 x 12.0
GH5K60-600	120	60	5KVA	30.0 x 24.0 x 12.0
GH7.5K60-600	120	60	7.5KVA	36.0 x 36.0 x 16.0
GH10K60-600	120	60	10KVA	36.0 x 36.0 x 16.0
GH15K60-600	120	60	15KVA	48.0 x 30.0 x 16.0
GH20K60-600	120	60	20KVA	48.0 x 30.0 x 16.0
GH25K60-600	120	60	25KVA	54.0 x 36.0 x 16.0
GH30K60-600	120	60	30KVA	54.0 x 36.0 x 16.0
GH35K60-600	120	60	35KVA	54.0 x 36.0 x 16.0

THREE PHASE MODEL SELECTION

MODELS	OUTPUT VAC	OUTPUT FREQ	OUTPUT POWER	DIMENSIONS H x W x D (Inches)
GS1.5K3/6-600(120/208)	120/208	60	1.5KVA	Consult Factory
GS3K3/5-600(120/208)	120/208	60	3KVA	Consult Factory
GS4.5K3/6-600(120/208)	120/208	60	4.5KVA	Consult Factory
GH6K3/6-600(120/208)	120/208	60	6KVA	Consult Factory
GH9K3/6-600(120/208)	120/208	60	9KVA	Consult Factory
GH15K3/6-600(120/208)	120/208	60	15KVA	Consult Factory
GH20K3/6-600(120/208)	120/208	60	20KVA	Consult Factory
GH25K3/6-600(120/208)	120/208	60	25KVA	Consult Factory
GH30K3/6-600(120/208)	120/208	60	30KVA	Consult Factory
GH35K3/6-600(120/208)	120/208	60	35KVA	Consult Factory

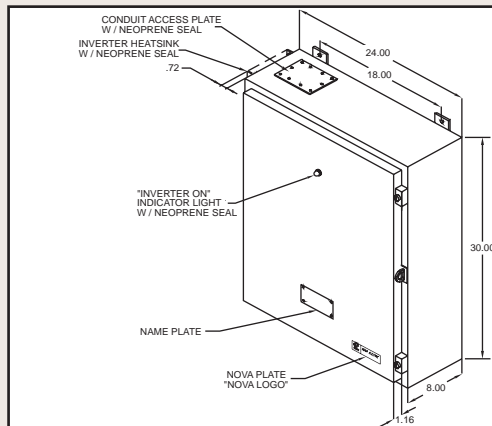

TYPICAL GH2K60-600 CABINET

NOTES:

1. INVERTER CABINET HAS (4) MTG EARS THE BOTTOM (2) CANNOT BE SEEN IN THIS VIEW
2. FINISH: ANSI #61 GREY, SEMIGLOSS
3. ENCLOSURE TYPE: NEMA 12

